

## Nanjing Spare Composite Product Information List

工字钢 I-beam	No.	A	B/B2	t	Serial Number
 <p>The diagram shows a cross-section of an I-beam. The total height is labeled 'A'. The top flange width is labeled 'B'. The bottom flange width is labeled 'B2'. The web thickness is labeled 't'.</p>	1	200	200	10	I-0441
	2	200	100/100	9.5	I-0012
	3	175	125/100	8	I-0847
	4	152.4	76.2/76.2	9.53	I-0633
	5	152.4	76.2/76.2	6.35	I-0725
	6	152	80/80	10	I-0016
	7	139.7	63.5	6.35	I-0722
	8	126	90	6.5/7	I-0853
	9	120	120/120	8	I-0329
	10	120	70/70	8	I-0011
	11	116.5	80/80	5	I-0567
	12	110	15	5/7	I-0729
	13	103	100/60	6.35	I-0009
	14	102	51/51	6.4	I-0015
	15	65	30/30	3	I-0017
	16	58	30/30	3	I-0014
	17	51	18/18	5	I-0005
	18	43	86	6/4	I-0521
	19	40	30/30	2	I-0013
	20	40	30/30	3	I-0007
	21	38	15/15	4	I-0001
	22	25.4	15/15	4	I-0002
	23	25	30/30	3	I-0006
	24	80	60/60	3.3/4	I-0617

甲板 deck	No.	A	B	t1/t2	Serial Number
	1	609.6	28.58	4.5/4.5	JB-0634
	2	540	28	4	JB-0830
	3	500	40	4/5	JB-0295
	4	500	40	4	JB-0775
	5	309	26	3.5/3.5	JB-0349
	6	304.8	54.15	6.3/6.3	JB-0296
	7	304.8	54.15	5/4.5	JB-0297
	8	750	3		PB-0308
整体卫浴甲板	No.	A	B	t1/t2	Serial Number
	1	500	40	2.8/4	JB-0492
	2	462	40	3/3	JB-0486
	3	450	40	2.8/4	JB-0485
	4	450	40	2.8/4	JB-0487
	5	450	40	2.8/4	JB-0488
	6	148	81	3/3	JB-0489
双孔甲板	No.	A	B	t/t2	Serial Number
	1	301	160	8/5 (5.5)	JB-0294-A
	2	400	220	11/6.5	JB-0416
	3	301	160	6/4	JB-0294-B
角钢 angle	No.	A	B	t	Serial Number
	1	170	80	5	L-0330
	2	152.4	152.4	9.52	L-0803

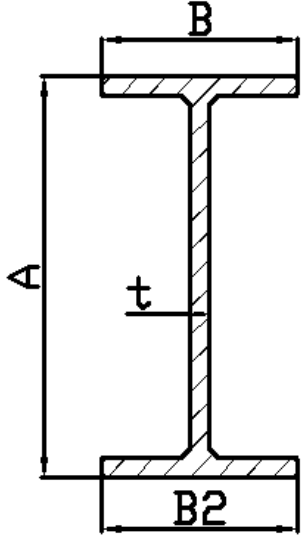
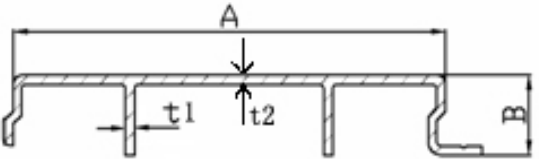
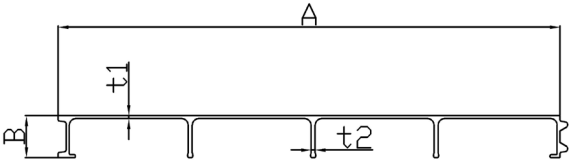
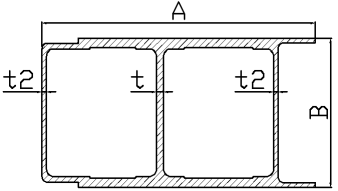
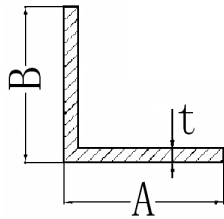

3	150	80	3	L-0641
4	101.6	101.6	6.35	L-0637
5	100	100	8	L-0035
6	100	100	6	L-0562
8	100	50	8	L-0019
9	90	60	5	L-0028
10	88.9	88.9	6.35	L-0653
11	76.2	76.2	6.35	L-0022
12	76	76	9.5	L-0023
13	75	75	10	L-0030
14	75	75	6	L-0027
15	70	30	6.35	L-0038
16	61.8	31.7	2.5	L-0343
17	60.5	43.8	2.8	L-0461
18	60	40	7	L-0701
19	60	60	8	L-0034
20	50.8	50.8	6.35	L-0026
21	50	50	3	L-0033
22	50	50	4	L-0037
23	50	35	5	L-0032
24	50	50	5	L-0029
25	50	50	6	L-0464
26	50	48	3	L-0805
27	50	38	3	L-0773
28	45	45	5	L-0021
29	40	40	4.2	L-0025
30	38.1	38.1	6.35	L-0652
31	35	35	5	L-0020
32	28	28	3	L-0036
33	25	25	3	L-0031

34	50	50	2.8	L-0438
35	60	40	2.8	L-0421
36	120	60	2.8	L-0427
37	100	25	2.8	L-0408
38	120	100	5	L-0514
39	70.5	13.2	3.3	L-0610
40	69.5	15	5	TL-0611
41	30	36	3	L-0818

方管 box	No.	A	t	Serial Number
	1	180	15	F-0857
	2	101.6	9.52	F-0656
	3	101.6	6.35	F-0051
	4	101.6	6	F-0051-6
	5	100	10	F-0627
	6	90.6	4.3	F-0463
	7	90	6	F-0407
	8	88.9	6.35	F-0654
	9	88.5	12.5	F-0623
	10	88.5	6.15	F-0047
	11	88.5	3.1	F-0519
	12	82	6.35	F-0415
	13	82	6	F-0415-6.0
	14	80	3.5	F-0621
	15	80	12	F-0546
	16	76.2	9.52	F-0655
	17	76.2	6.35	F-0046
	18	76.2	4	F-0508
	19	75	6	F-0045
	20	68	5	F-0748
	21	64.5	3	F-0054
	22	63.2	5.9	F-0053
	23	62.6	5.7	F-0437
	24	60	4.5	F-0052
	25	60	2.5	F-0622
	26	60	4.25	F-0052-4.25
	27	60	4	F-0783
	28	58.2	3	F-0055
	29	50.8	6.35	F-0041-6.35

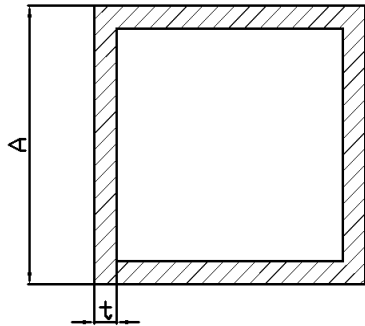



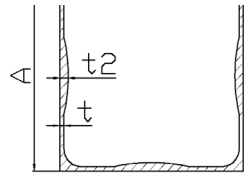

5	190.5	3.18/6.35	F-0058
6	139.7	3.18/6.35	F-0057
7	142.88	3.18/6.35	F-0382
8	193.68	3.18/6.35	F-0383
9	244.48	3.18/6.35	F-0384
10	295.28	3.18/6.35	F-0385

**凹形方管**

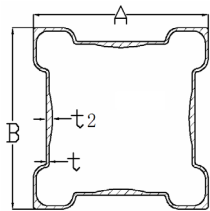

	A	B	t/t2	Serial Number
1	190.5	190.5	3.175/6.5	F-0337

**凹角方管**

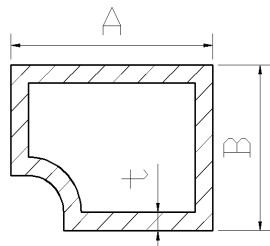

	A	B	t	Serial Number
1	23	18	2	F-0338

**加强方管**

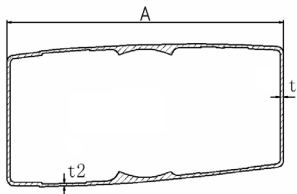

	A	t/t2	Serial Number
1	330	4/3	F-0328
2	225	3/2.5	F-0348

矩形管 rect tube

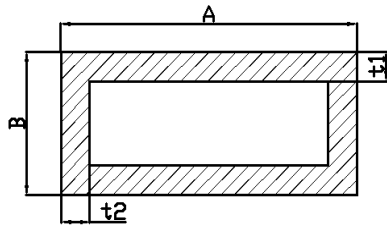

No.	A	B	t1/t2	Serial Number
1	800	300	3.5/10	J-0846
2	190.5	45.212	2.46	J-0711
3	160	60	3.5	J-0512
4	152.4	101.6	9.5/9.5	J-0071
5	140	60	7	J-0858
6	130	60	3.5	J-0513
7	120	90	10	J-0692
8	120	60	7/7	J-0483
9	101.6	50.8	3.125/6.35	J-0070
10	101.6	50.8	5/5	J-0070
11	101.6	50.8	8.05/8.55	J-0062
12	100	50	4	J-0799
13	95.5	45.5	4	J-0069
14	90	40	4/7	J-0068
15	75(75.9)	35(35.3)	5/5(3.5/5.1)	J-0073
16	75	35	4.7/7.1	J-0532
17	65.5	30	4/5	J-0065
18	63.5	37	3.5/3.5	J-0066
19	60	36	2/2	J-0608
20	60	20	2	J-0753
21	50.8	40.64	2.28	J-0712
22	50.8	30	3/6.35	J-0072
23	50	30	3	J-0800
24	50	25	3/3	J-0368
25	48	31	4/4	J-0261
26	40	30	2.5	J-0784
27	38	15	3/3	J-0263
28	38	23.8	5/5	J-0074
29	37	20	2.5/2.5	J-0333



30	27.7	13.6	3/3	J-0064
31	22	20	3/3	J-0511
32	19	16	2	J-0856
33	18.16	10.8	z. z80/z. z80 c	J-0063
34	95	68	6/6	J-0412
35	120	60	3	J-0451
36	190	90	4	J-0450
37	210	110	4	J-0449
38	80	40	4	J-0618
39	25	16	2	J-0763
40	19	16	2	J-0808
33	68	32	3.2/3.6	J-0264

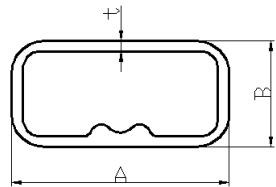

槽材 channel	No.	A	B	t/t2	Serial Number
	1	206	272	3	C-0794
	1	300	90	15/15	C-0079
	2	280	70	12/12	C-0094
	3	254	69.85	12.7/12.7	C-0651
	4	203.2	55.56	6.35/6.35	C-0650
	5	203.2	55.56	9.52/9.52	C-0639
	6	200	80	4/6	C-0602
	7	200	60	9.5/9.5	C-0105
	8	200	60	8	C-0419
	9	193	30	3/3	C-0108
	10	140	80	14	C-0777
	11	140	50	6/6	C-0372
	12	180	60	8/8	C-0093
	13	152.4	41.28	6.35/6.35	C-0631
	14	152.4	42.9	9.5/9.5	C-0102
	15	152.4	39.9	9.5/9.5	C-0101
	16	150	75	8/6	C-0466
	17	150	50	6/6	C-0090
	18	140	60	2.5	C-0842
	19	139.7	38.1	6.35	C-0721
	20	139.7	38.1	4.76/4.76	C-0638
	21	127	45	6.35/6.35	C-0100
	22	120	60	8/8	C-0078
	23	120	60	5/5.2	C-0467
	24	120	65	10/15	C-0545
	25	103	60	6.35/6.35	C-0091
	26	101.6	28.6	6.35/6.35	C-0099
	27	100	50	10	C-0696

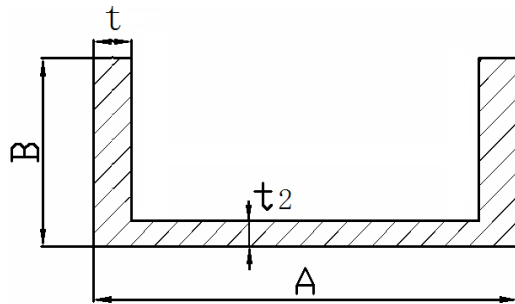

28	100	50	6/6	C-0089
29	96.5	85	5/5	C-0568
30	90	45	5.2/5.2	C-0394
31	88.9	38.1	4.76/4.76	C-0630
32	87	33	3.3/3.3	C-0082
33	85	85	10	C-0678
34	85	30	6/3.65	C-0334
35	84.5	33.3	3.3	C-0083
36	84	30	5/3.3	C-0080
37	84	30	5/3.45	C-0085
38	84	30	5/4.3	C-0086
39	80	45	3.5/3	C-0787
40	80.5	30	3	C-0768
41	80	30	3.3/3.3	C-0314
42	80	30	3.1/2.6	C-0389
43	80	30	3/3	C-0396
44	76.2	25	6.35/6.35	C-0077
45	75	35	5/5	C-0454
46	75	50/30	2.5	C-0666
47	60	60	4.8/4.8	C-0104
48	40	60	4	C-0861
49	60	35	3	C-0772
50	55	70	5/5	C-0084
51	55	37	4/4	C-0281
52	50	30	4/4	C-0107
53	51	25	3	C-0767
54	46	40*30	3/3	C-0490
55	44.5	31.3	3.3	C-0081
56	44	28	3.3/2.6	C-0313
57	44	28	3.1/2.5	C-0390



槽盒 cable tray		No.	A	B	t/t2	Serial Number
		1	600	80	4.5/5	C-0592
		2	600	50	4.5/5	C-0431
		3	400	80	4/5	C-0420
		4	400	50	4/5	C-0432
		5	300	50	5/4	C-0155
		6	300	50	5/3	C-0169
		8	200	50	5/3	C-0154
		9	200	50	4/3	C-0165
		10	200	80	5/3	C-0164
		11	200	50	3/3	C-0352
		12	150	50	5/3	C-0153
		13	150	50	4/3	C-0157
		14	150	80	4/3	C-0158
		15	100	50	5/3	C-0152
		16	100	50	4/3	C-0156
		17	100	80	4/3	C-0160
		18	100	50	3/3	C-0350
		19	50	50	3/3	C-0163
		20	50	80	4/3	C-0162
		21	50	50	3/3	C-0161
		22	80	80	3.2/3.2	C-0159
		23	200	100	4.5/3.5	C-0148
		24	100	50	3/3	C-0147
		25	100	40	4/3	C-0812
		26	150	40	4/3	C-0813
		27	200	40	4/3	C-0814

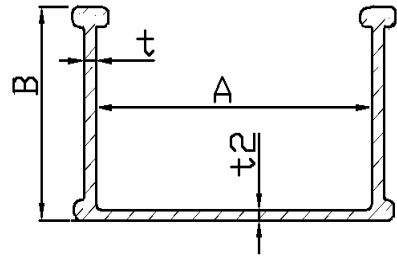

	28	300	40	5/3	C-0815

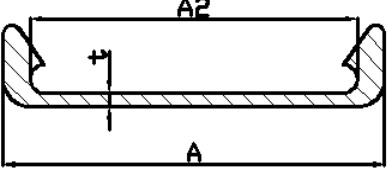
槽盖 cover	No.	A	A2	t	Serial Number
	2	236		3	C-0172
	3	220		3	C-0353
	4	184		3	C-0341
	5	120		3	C-0351
	6	96		3.2	C-0170
	7	84		3	C-0173
	8	134		3	C-0174
	9		100	4	C-0175
	10		200	4.5	C-0176
	11		300	5	C-0177

圆管 round tube	No.	A	t	Serial Number
	1	244.475	3.24	G-0715
	2	193.675	3.24	G-0713
	3	168	6	G-0506
	4	155	6	G-0505
	5	152	4	G-0529
	6	130	6	G-0504
	7	123	6	G-0503
	8	117	6	G-0502
		106	3.5	G-0126
	9	104	6	G-0501
	10	98	6	G-0500
	11	92	8	G-0517
	12	92	6	G-0499
	13	85	6	G-0498
	14	82	3	G-0587
	15	79	6	G-0497
	16	76	6	G-0124
	17	76	4	G-0125
	18	73	5	G-0123
	19	71	3.5	G-0122
	20	60.33	4.7	G-0462
	21	60	3.5	G-0121
	22	60	2.63	G-0146
	23	51.6	2.55	TX-0199
	24	50	5	G-0585
	25	50	2.6	G-0750
	26	50	2.6	G-0751
	27	50	3.5	G-0752
	28	50	2.8	G-0413



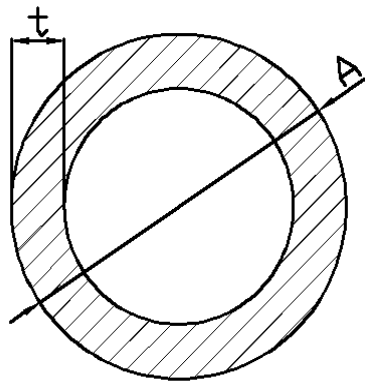

29	50	2	G-0586
31	48.5	6.75	G-0410
32	48.5	2.5	G-0439
33	44	2.65	G-0588
34	40	4	
35	40	2	G-0584
36	39.7	2.45	G-0831
~	39.7	3.2	G-0340
37	38.35	4.83	G-0680
38	38	5	G-0120
39	38.1	4.7	G-0522
40	38	2.45	G-0620
41	38	3	G-0132
42	36	5	
43	36	2.2	G-0460
44	36	3	G-0311
45	32.14	3.5	G-0764
46	31.5	3.18	G-0315
47	31.5	2.54	G-0315-2.5
48	31.5	2.25	G-0469
49	32/34.5	3.25	G-0138
50	32	4.8	G-0119
51	32	3	G-0130
52	32	2	G-0117
53	32	2.5	G-0118
54	30.3	2.5	G-0375
55	30	4.8	G-0131
56	30	2	G-0116
57	30	2.5	G-0342
58	28	3	G-0115

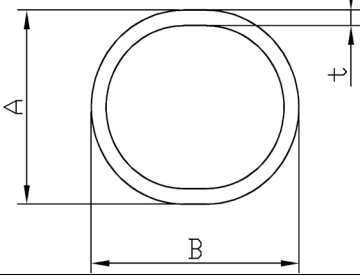
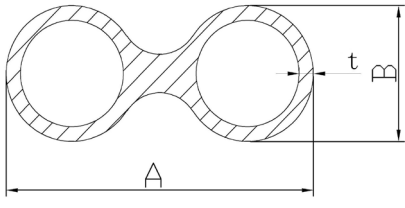
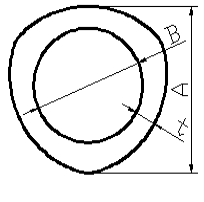

	2	23.01	19.84	5.06	G-0507
<p>双管 Double tube</p>		A	B	t	Serial Number
	1	66.5	28.5	3.1	G-0434
<p>三角管</p>		A	B	t	Serial Number
	1	29.7	20.32	3.94	G-0373

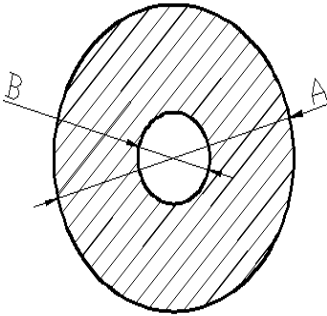
纤维杆 tent poles	No.	A	B	Serial Number
	1	12.7	4.0	XW-0231-4.0
	2	12.7	4.5	XW-0231-4.5
	3	12.7	5.0	XW-0231-5.0
	4	12.7	9.0	XW-0231-9.0
	5	9.5	3.0	B-0219-3.0
	6	8.5	3.2	XW-0235-3.2
	7	8.5	3.5	XW-0235-3.5
	8	8.5	3.8	XW-0235-3.8
	9	8.5	5.0	XW-0235-5.0
	10	7.9	3.2	XW-0232
	11	7.9	3.5	XW-0233
	12	7.9	4	XW-0234
	13	7	3.2	B-0216-3.2
	14	7	3.5	B-0216-3.5
	15	6	3.0	XW-0230-3.0
	16	6	3.2	XW-0230-3.2
	17	14	9.0	B-0227-9.0
	18	11	4.0	B-0221-4.0
	19			
	20			
	21			

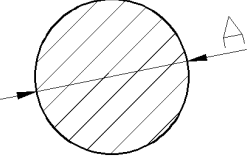
圆棒 rod	No.	A	Serial Number
	1	38	B-0224
	2	32	B-0223
	3	28	B-0115
	4	25.4	B-0211
	5	25	B-0374
	6	24	B-0210
	7	23.7	B-0209
	8	22	B-0208
	9	20	B-0207
	10	18	B-0206
	11	16	B-0228
	12	16/8	B-0675
	13	16/12	B-0675
	14	14	B-0227
	15	12.7	B-0222
	16	12.5	B-0226
	17	12	B-0225
	18	11	B-0221
	19	9.5	B-0219
	20	9	B-0797
	21	8.5	B-0218
	22	7.9	B-0217
	23	7	B-0216
	24	6.32	B-0215
	25	6	B-0214
	26	5	B-0213
	27	4	B-0212

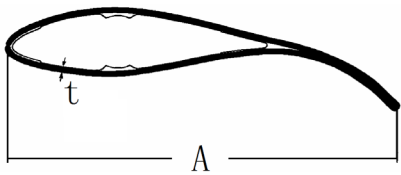
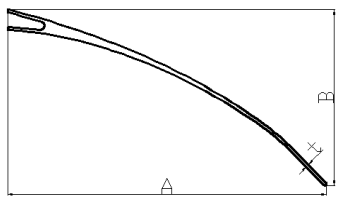
叶片blade		No.	A	t	Serial Number
	1	900	3.2	YP-0452	
	2	610	3.5	YP-0458	
	3	610	4	YP-0256	
		590	3	YP-0720	
		540	4.5	YP-0694	
	4	533	3	YP-0493	
	5	371	3	YP-0443	
	6	355	2.5	YP-0258	
7	270	3.0	YP-0740		
		A	B	t	Serial Number
	1	533	284.9	5	YP-0339
扁条 flat		No.	A	t	Serial Number
	1	200	9.5	BT-0642	
	2	136	6.35	BT-0236	
	3	110	4	BT-0859	
	4	101.6	12.7	BT-0635	
	5	101.6	6.35	BT-0636	
	6	100	2.8	BT-0583	
	7	87.9	5	BT-0245	
	8	80	8	BT-0244	
	9	76.2	12.7	BT-0629	
	10	76.2	6.35	BT-0806	
	11	76	22	BT-0241	
	12	60	3	BT-0246	
	13	50	4	BT-0247	

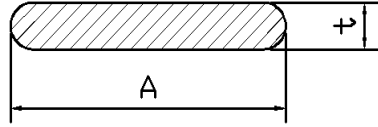

14	40	8	BT-0832
15	40	5	BT-0242
16	40	3	BT-0475
17	40	4	BT-0249
18	39	13	BT-0801
19	38.5	13	BT-0358
20	32	6	BT-0471
21	32	3	BT-0251
22	30	4	BT-0474
23	30	3	BT-0798
24	28.58	3	BT-0312
25	23	2	BT-0359
26	20	4	BT-0254
27	20	6	BT-0253
28	16	6	BT-0553
29	16	2	BT-0250
30	15	4.5	BT-0473
31	15	2.5	BT-0252
32	15	4	BT-0238
33	9	2.5	BT-0248
34	53	2.5	BT-0523
35	50	3.2	BT-0738

平板 panel

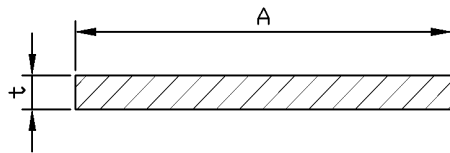

	A	B	Serial Number
1	598	3	PB-0793
2	582	4	PB-0309
3	500	6	PB-0578
4	270	8	PB-0779

太阳能边框 solar bezel

No.	A	B	t/t2	Serial Number
-----	---	---	------	---------------

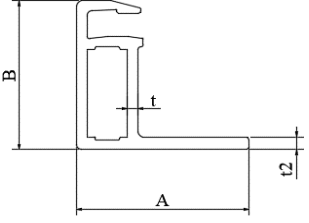
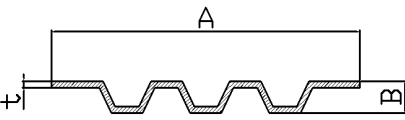
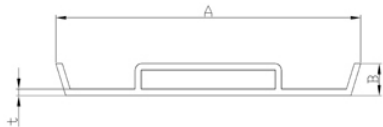
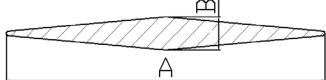
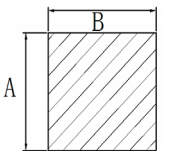
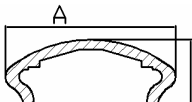
	1	33	30	2/2.5	BK-0840
	2	33	30	2/2.5	BK-0845
<b>踢脚板 kick plate</b>					
	1	150	15	3	TJ-0306
	2	110	18.5	3.5	TJ-0300
	3	150	15	5	TJ-0496
<b>踢脚板 kick plate</b>					
	1	150	15	3	TJ-0305
<b>菱形条 diamond flat</b>					
	1	24	4		LX-0269
<b>方棒 square rod</b>					
	1	25	10		JB-0362
	2	10	11		FB-0361
	3	6.4	6.4		FB-0270
	4	10	10		FB-0484
<b>扶手 handrail</b>					
	1	75	60	4.5	FS-0271



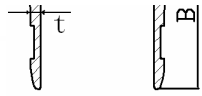

空腹大板 splank

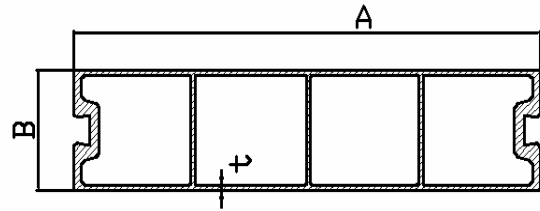

No.	A	B	t	Serial Number
1	634	60	3.2/3.5	KF-0665
2	600	80	4/3.5	KF-0590
3	600	60	3.2/3.5	KF-0664
4	317	60	3.2/3.5	KF-0704
5	300	60	2.8/3.5	KF-0705
6	617	60	3.2/3.5	KF-0706
7	600	60	2.8/3.5	KF-0707
8	140	20	2.5	KF-0790

空腹板

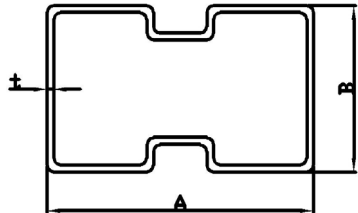

	A	B	t	Serial Number
1	270	200	5	KX-0447
2	200	120	5	KX-0446

空腹板

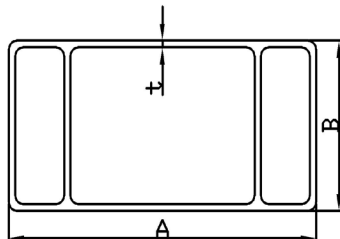

	A	B	t	Serial Number
1	1000	90	4	KX-0510
2	491	49.1	5/3.8	KF-0645
3	241	49.1	5/3.8	KF-0669
4	227.25	210	3.2	KF-0757
5	150	149.28	3.2	KF-0758
6	200	100	4	KX-0445
7	190	38	3	KX-0481
8	180	80	4	KX-0448

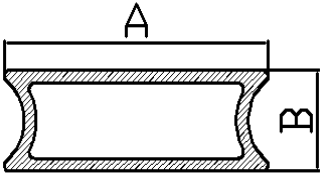
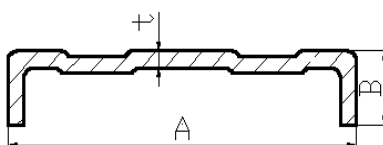
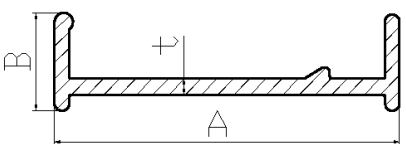
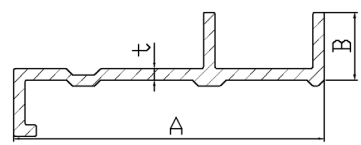
		9	170.5	49.1	3.8	KF-0644
		10	170.5	49.1	3.8	KF-0668
		11	116	49.1	3.8	KF-0667
		12	116	49.1	3.8/5	KF-0670
<b>中腿 center leg</b>			<b>A</b>	<b>B</b>		<b>Serial Number</b>
	1	66	23.5		ZT-0325	
<b>桥帮 cable ladder rail</b>		<b>No.</b>	<b>A</b>	<b>B</b>	<b>t</b>	<b>Serial Number</b>
	1	200	25	5.5	Q-0185	
	2	100	25	4.5	Q-0182	
	4	150	42	4	Q-0187	
	5	150	42	7	Q-0186	
	6	100	37	4	Q-0183	
	7	75	32	6	Q-0179	
	8	70	18	4	Q-0331	
	9	150	30	5	Q-0181	
	10	135	30	5	Q-0180	
<b>其他产品</b>						
<b>天线罩 radome</b>		<b>No.</b>	<b>A</b>	<b>B</b>	<b>t</b>	<b>Serial Number</b>
		1	289	85	2.5	TX-0201
		2	340	230	2.8	TX-0194

+. .

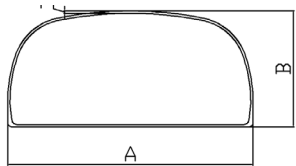

3	264	99.71	2.8	TX-0195
4	262	118	2.8	TX-0189
5	262	120	2.5	TX-0196
8	157	95.5	2.5	TX-0197
9	152	49.3	2.8	TX-0190

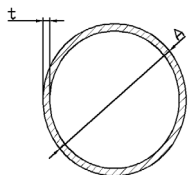

10	280		2.8	TX-0198

梯形管 trapezoid tube

No.	A	B/B2	t	Serial Number
1	140	41.2/61	3.5	TX-0657
2	76	158/9.9	3.5	TX-0658

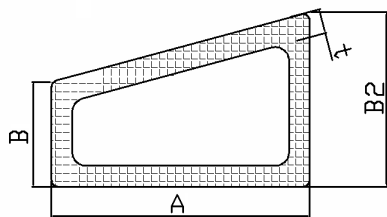

山字型 E-snape

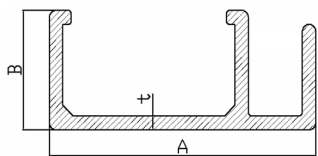

No.	A	B	t	Serial Number
1	144	30	5	S-0356

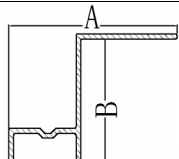

门框 doorframe

No.	A	B	Serial Number
1	100	80	MK-0290
2	100	100	MK-0418

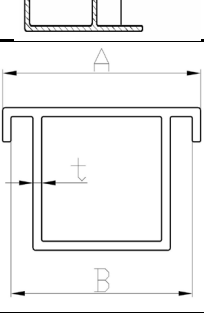
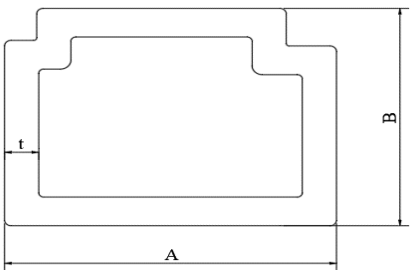
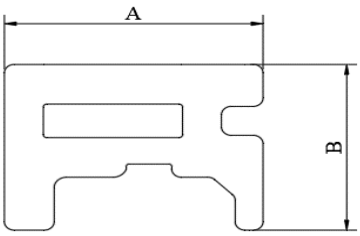

	3	A 72	B 66	t 3.2	Serial Number MK-0435
门框型材	No.	A	B	t	Serial Number
	1	49.6	38.7	5.11	MK-0769
	1	33.02	25.07		MK-0770
	1	39.1	44.9		YX-0774

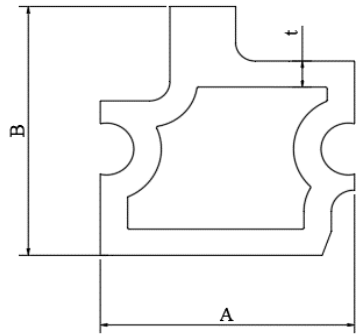
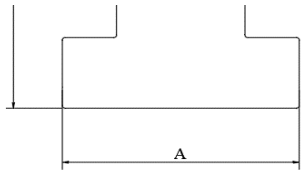

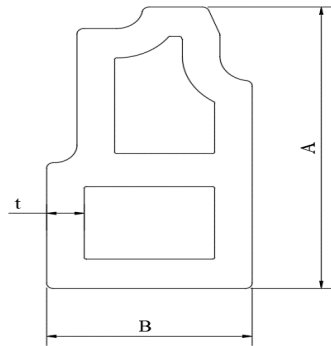

No.	A	B	t	Serial Number
1	37	38.18	4	MK-0795

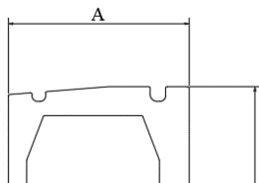

No.	A	B	t	Serial Number
1	38.29	21.87	4	MK-0796

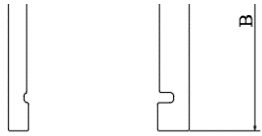

No.	A	B	t	Serial Number
1	40.7	48.11		MK-0802

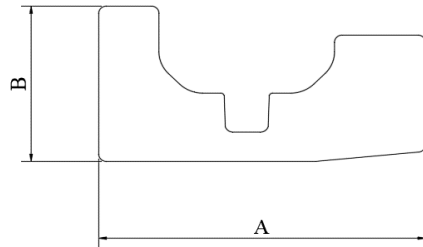

No.	A	B	t	Serial Number
1	42.4	21.42		MK-0807

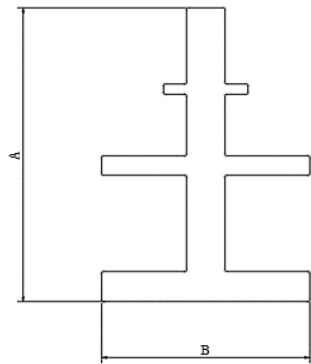

No.	A	B	t	Serial Number
1	64.2	43		MK-0809

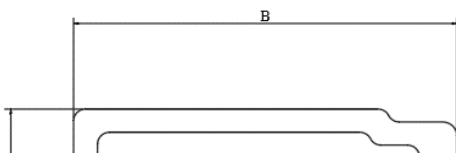

No.	A	B	t	Serial Number
1	26.63	79.69		MK-0810

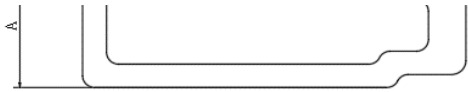

门边条 door edge strip		No.	A	B	t	Serial Number
	1	10	25		MK-0756	
门框条 door frame strip		No.	A	B	t	Serial Number
		25	45	3.5	MK-0755	
门板箱体 door panel box		No.	A	B	t	Serial Number
		288.6	25	4	MB-0788	

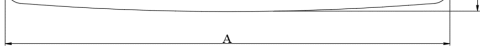
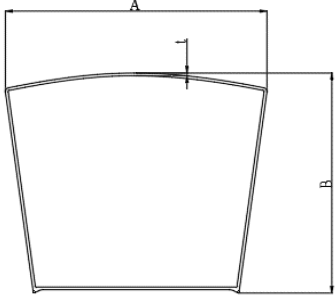
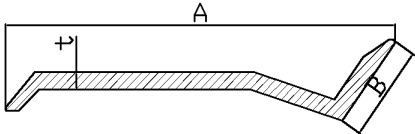
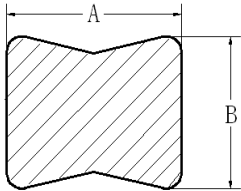
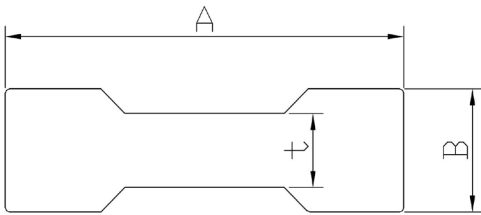
					
		368.7	323	4	XT-0789
<b>钩状型材 "7" section profile</b>	<b>32</b>	<b>A</b>	<b>B</b>	<b>t</b>	<b>Serial Number</b>
	1	139.15	29	5	GZ-0284
<b>连接件 connector</b>	<b>No.</b>	<b>A</b>	<b>B</b>	<b>t</b>	<b>Serial Number</b>
	1	23	19.5		LJ-0397
	2	50	15	9	I-0386

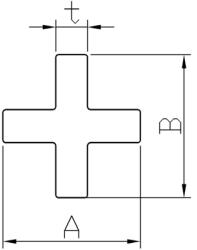
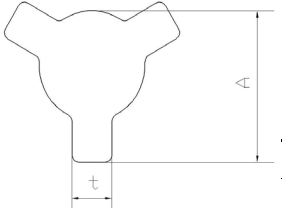
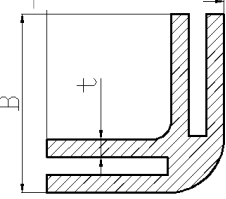
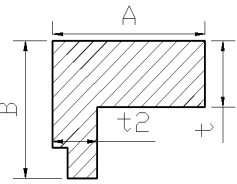
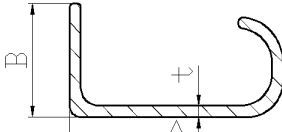

	<b>No.</b>	<b>A</b>	<b>B</b>	<b>t</b>	<b>Serial Number</b>
	1	26	26	6	LJ-0426
	2	16	16	4	LJ-0478
	3	14	14	3.5	LJ-0693
	4	11		3	LJ-0491
	<b>No.</b>	<b>A</b>	<b>B</b>	<b>t</b>	<b>Serial Number</b>
	1	25	25	3	L-0286
<b>L块</b>					
	<b>No.</b>	<b>A</b>	<b>B</b>	<b>t</b>	<b>Serial Number</b>
	1	15.92	13.94	6.5/4.5	L-0327
<b>C型槽 C channel (内外C)</b>					
	1	82	31	3.17	CX-0293
	2	60	31	3.17	CX-0292

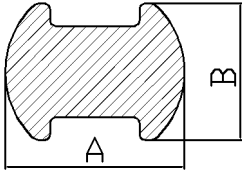
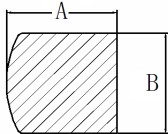
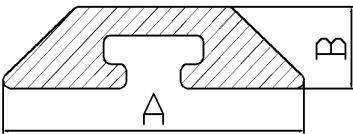
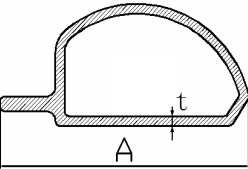
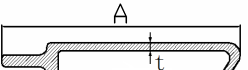
梅花棒 cross rod 1		A	B	Serial Number
	1	14	10.54	MH-0298
	2	9.11		MH-0387
梅花插条 cross rod 2		A	B	Serial Number
	1	7.5	7	MH-0299
	2	7	5	MH-0388
平板插条 connector		A	B	Serial Number
	1	39	10	PC-0302
上托盘 top tray beam		A	t	Serial Number
	1	171.4	5	ST-0335
下托盘 bottom tray beam		A	t	Serial Number
	1	209.6	6	XT-0336

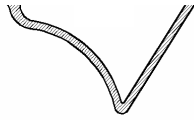

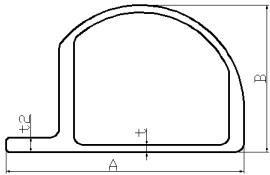
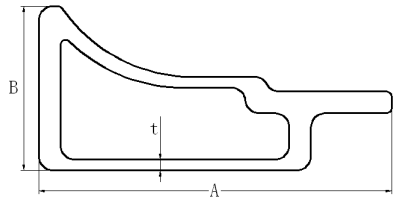
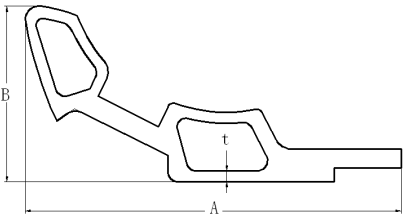
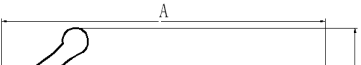
上唇材		A	B	t/t2	Serial Number
1		157.23	97.03	4.83/9.65	SC-0364
下唇材		A	B	t	Serial Number
		157.23	97.03	4.83	XC-0365
鱼上唇材		A	B	t	Serial Number
		177.77	81.51	5.08	YSC-0366
鱼下唇材		A	B	t	Serial Number
		180.8	114.7	5.08	YSC-0367

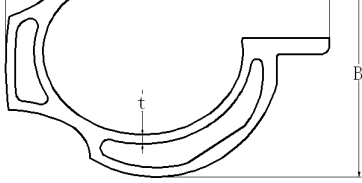
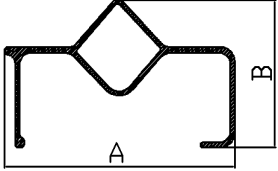
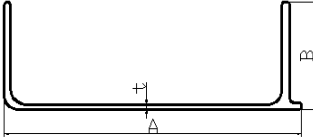
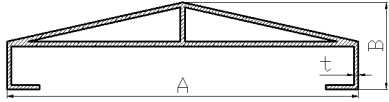
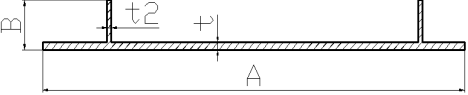
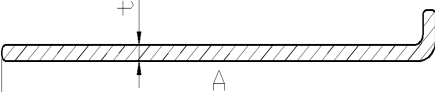
					
<b>Σ型材 "Σ" profile</b>		<b>A</b>	<b>B</b>		<b>Serial Number</b>
	1	190.2	77		XG-0282
	2	190.2	114.81		XG-0316
	3	190.2+114.81	114.81		XG-0317
<b>槽型刮板</b>		<b>A</b>	<b>B</b>	<b>t</b>	<b>Serial Number</b>
	1	188.9	63.5	3.05	C-0357
<b>报警盒三角材</b>		<b>A</b>	<b>B</b>	<b>t</b>	<b>Serial Number</b>
		268	65	3.5	ST-0360
<b>报警盒底板</b>		<b>A</b>	<b>B</b>	<b>t/t2</b>	<b>Serial Number</b>
	1	246	27	4/2.5	DB-0363
<b>插板</b>		<b>A</b>	<b>t</b>		<b>Serial Number</b>
	1	100	3		CB-0301

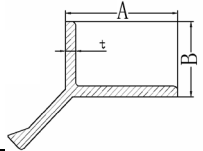
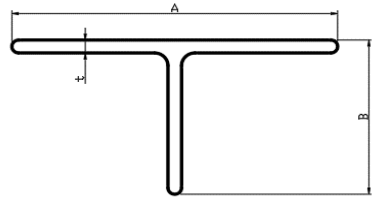
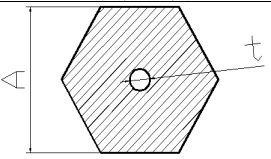
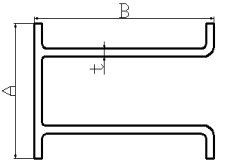
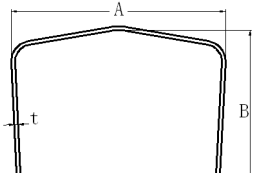
Y型材					
		A	B	t	Serial Number
	1	55	35	5	Y-0283
T型材					
		A	B	t	Serial Number
	1	152.4	76.2	6.35	T-0640
	2	50	38	2/4	T-0849
	3	40	11	2	T-0855
六角型材					
		A	t	Serial Number	
	1	22	6.5	L-0345	
P型材					
		A	B	t	Serial Number
	1	100	140	5	P-0395-2
防护罩					
		A	B	t	Serial Number
	1	169.2	137.2	2.8	Z-0369
	2	162	130	2.8	Z-0370
	3	111	30	2.1	G-0480

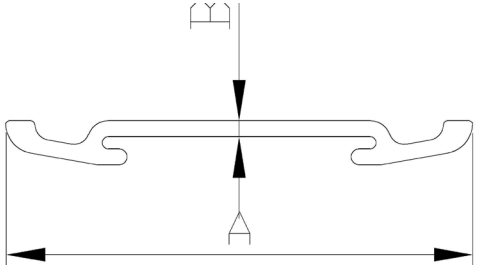
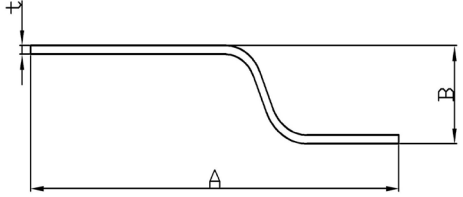
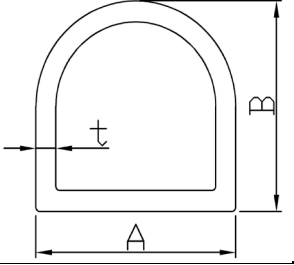
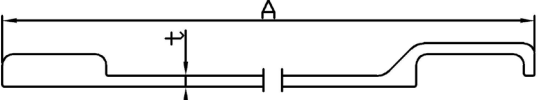
阳极板条		A	B	Serial Number	
	1	101.6	3.3	BT-0430	
Z型材		A	B	t	Serial Number
	1	200	45	4	Z-0440
		A	B	t	Serial Number
	1	50	50	5	D-0459
盖板		A	t	Serial Number	
	1	783	3	B-0468	

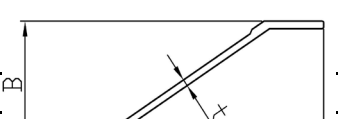
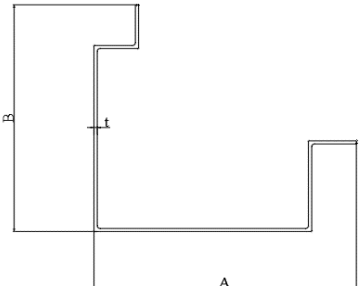
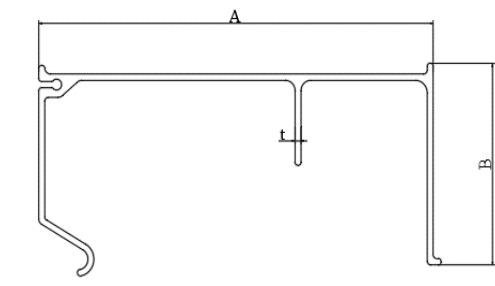
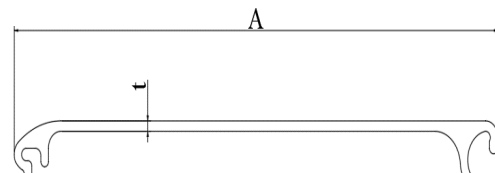
刮泥器		A	B	t	Serial Number
	1	75	34	1.8	YP-0476
	2	70	28	2	YP-0765
刮泥板		A	B	t	Serial Number
	1	241	228	3	ZXB-0823
	2	241	181	3	ZXB-0828
	3	240	140	3	ZXB-0836
	4	320	180	3	ZXB-0837
	5	210	200	3	ZXB-0841
刮泥板盖		A	B	t	Serial Number
		200	95	3	GNB-0825
刮泥板盖		A	B	t	Serial Number
		190.92		3	GNB-0829

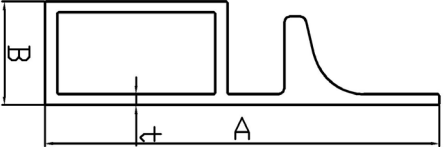
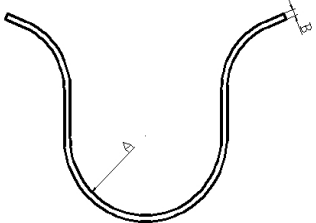
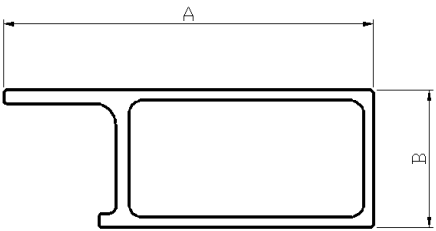
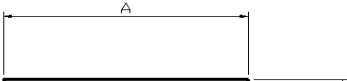
F型材					
		A	B	t	Serial Number
		190	48	5	F-0482
开口圆型材					
		A		B	Serial Number
	1	38		3	KY-0515
	2	10		3	KKY-0573
	3	25		3	KKY-0574
	4	45		3	KKY-0575
转角板					
		A	B	Serial Number	
	1	111	40	ZJ-0534	
拼接头					
		A	B	Serial Number	
	1	60	40	PJ-0535	



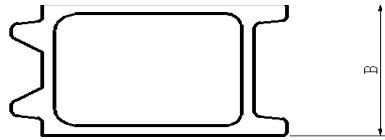

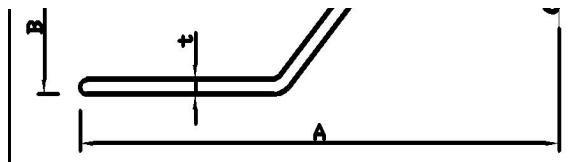
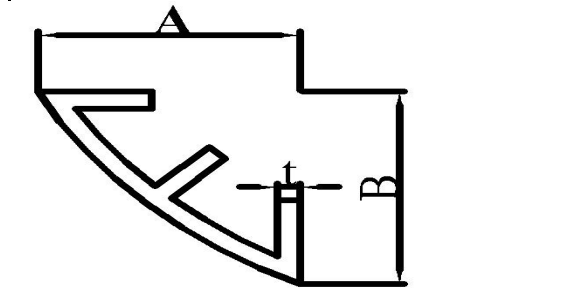
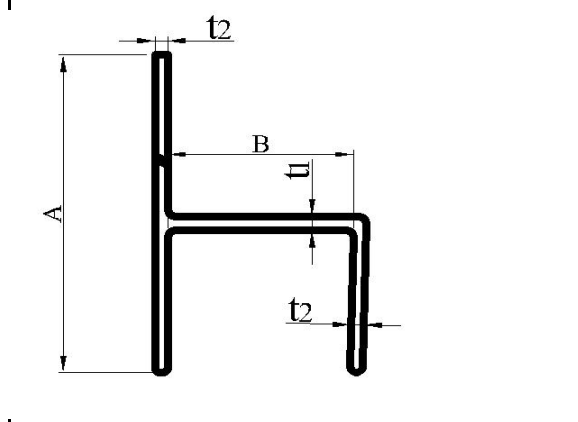
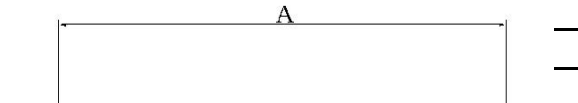

屋顶异型材					
	A	B	t	Serial Number	
	1	68.4	65	2.5	WDYC-0557
	2	71.8	70	2.5	WDYC-0660
	3	103.4	65	2.5	WDYC-0556
	4	153.4	65	2.5	WDYC-0647
	5	206.6	90	3.5	WDYC-0661
	6	110.25	90	2.5	WDYC-0718
	7	70	75	2.5	WDYC-0719
	8	106.8	70	2.5	WDYC-0744
	9	156.6	90	2.5	WDYC-0745
	10	102.5	90	2.5	WDYC-0817
	1	100	75	2.5	WDYC-0559
	2	150	75	2.5	WDYC-0746
	4	90	22.5	2.5	WDYC-0558

					
带肋曲板		A	B	t	Serial Number
	1	69	69	6	QB-0619
H型材	al Num	A	B	t1/t2	Serial Number
	1	223	51	4/3.5	HX-0646
异形工字钢	al Num	A	B	t1/t2	Serial Number
	1	156	65	12/4	I-0643

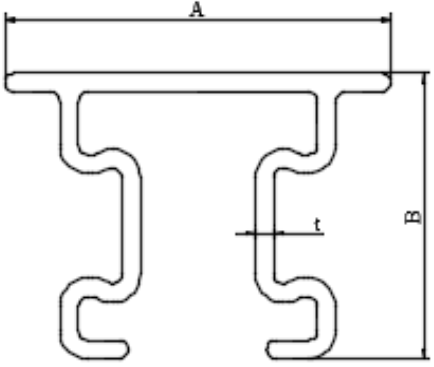
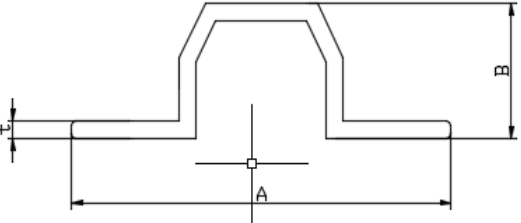

支架异型材	al Num	A	B	t1/t2	Serial Number
		84	60	4	YX-0695
礼帽型材	al Num	A	B	t1/t2	Serial Number
		88	30	3.9	YX-0716
		170	77	6	YX-0741
气浮板	al Num	A	B	t1/t2	Serial Number
		155	57	3.5	YX-0717





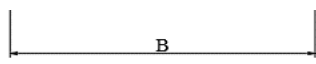

G型材

al Num	A	B	t	Serial Number
	64	58	2.8	YX-0781

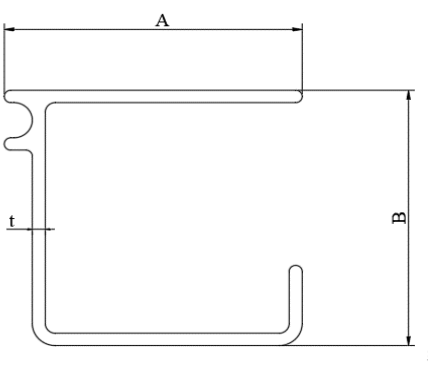

T型材

al Num	A	B	t	Serial Number
	143	107	3	YX-0782

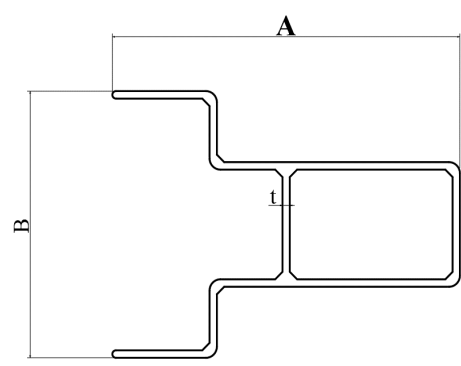

外齿圆弧

al Num	A	B	t1/t2	Serial Number
1	162	172	6	WCYH-0702











































#REF!







**Injection moulded parts**

Cast-in-place wall connectors

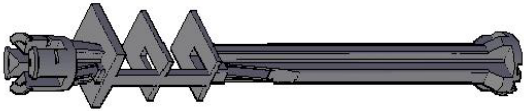
序号	A	B	Serial Number
1	320	30	
2	75		ZS-0691
	180	90	ZS-0714



--	--	--	--	--

100      70



AUX1L9B

